

DONNA

CE LED IP20  48V

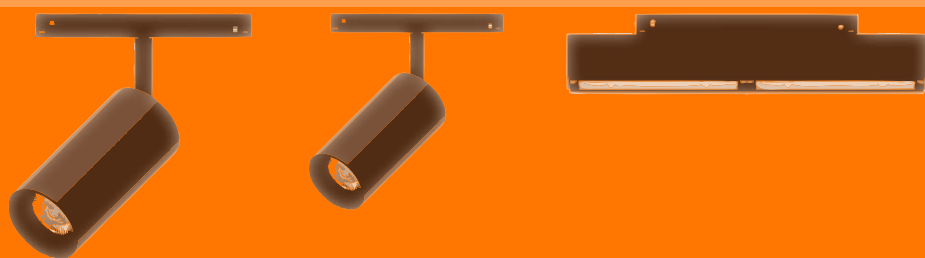

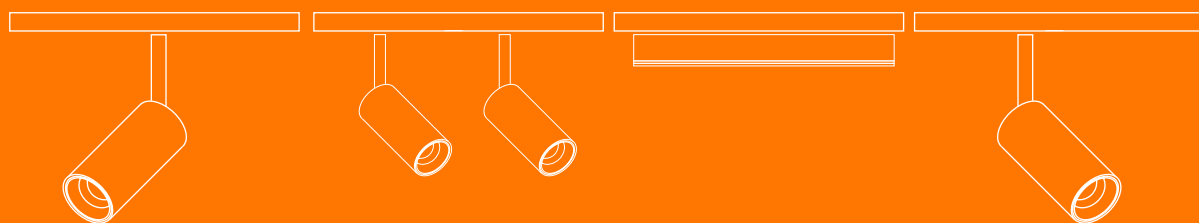

CIVIC[®]
LIGHT IN ITALY





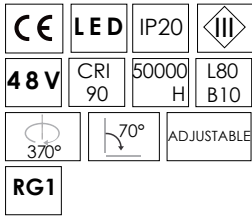



● 03- nero / black

D.



20°

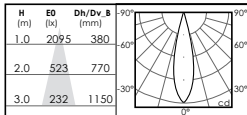

30°

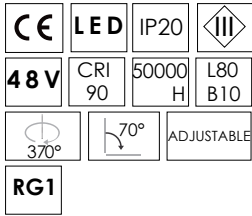
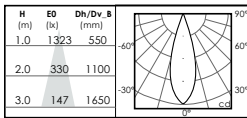

● 03- nero / black

D.



12°

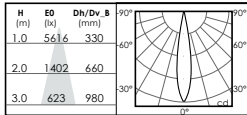

24°

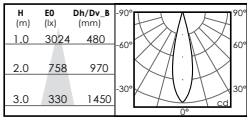

36°

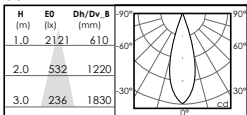

DONNA SMALL

Donna Spot 48V proiettore con 1 LED orientabile per il sistema MULTITRACK. Corpo in alluminio verniciato. Disponibile nella versione on-off o dimmerabile.

Donna Spot 48V adjustable LED spot for the MULTITRACK system. Aluminium body. Rough black colour. On/off or dimming versions available.

4000K/3000K

CODICE/CODE	W	K	LM
MVI.3703. D 6 7	9W	4000K	970
MVI.3703. D 6 8	9W	3000K	950

DIMMERABILE 1-10V 4000K/3000K

CODICE/CODE	W	K	LM
MVI.3713. D 6 7	9W	4000K	970
MVI.3723. D 6 8	9W	3000K	950

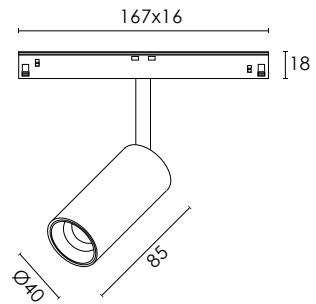

DONNA LARGE

Donna Spot 48V proiettore con 1 LED orientabile per il sistema MULTITRACK. Corpo in alluminio verniciato. Disponibile nella versione on-off o dimmerabile.

Donna Spot 48V adjustable LED spot for the MULTITRACK system. Aluminium body. Rough black colour. On/off or dimming versions available.

4000K/3000K

CODICE/CODE	W	K	LM
MVI.3705. D 6 7	14W	4000K	1370
MVI.3705. D 6 8	14W	3000K	1350

DIMMERABILE 1-10V 4000K/3000K

CODICE/CODE	W	K	LM
MVI.3715. D 6 7	14W	4000K	1370
MVI.3715. D 6 8	14W	3000K	1350

DIMMERABILE DALI  **4000K/3000K**

CODICE/CODE	W	K	LM
MVI.3725. D 6 7	14W	4000K	1370
MVI.3725. D 6 8	14W	3000K	1350

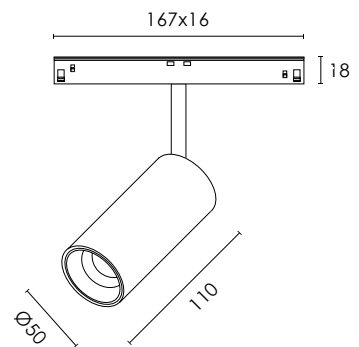

CE	LED	IP20	III
48V	CRI 90	50000 H	L80 B10
RG1			

DONNA LINEAR

Donna Linear 48V profilo per il sistema MULTI TRACK 48V. Corpo in alluminio verniciato nero raggrinzato. Disponibile nella versione on-off o dimmerabile.

Donna Linear 48V LED for the MULTI TRACK 48V system. Aluminium body. Rough black colour. On/off or dimming versions available.

● 03- nero / black

D.



90°

H (m)	EO (lx)	Dh/Dv.B (mm)
1.0	575	2450
2.0	143	4900
3.0	63	7340

CE	LED	IP20	III
48V	CRI 90	50000 H	L80 B10
RG1			

● 03- nero / black

D.



Y.

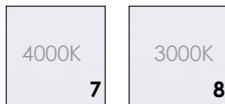

OPAL

H (m)	EO (lx)	Dh/Dv.B (mm)
1.0	575	2450
2.0	143	4900
3.0	327	7340

MICROPRISMATIC

H (m)	EO (lx)	Dh/Dv.B (mm)
1.0	575	2450
2.0	143	4900
3.0	327	7340

4000K/3000K

CODICE/CODE W K LM

MVI.5703.1 6 7 20W 4000K 1800

MVI.5703.1 6 8 20W 3000K 1700

DIMMERABILE 1-10V 4000K/3000K

CODICE/CODE W K LM

MVI.5713.1 6 7 20W 4000K 1800

MVI.5713.1 6 8 20W 3000K 1700

DIMMERABILE DALI 4000K/3000K

CODICE/CODE W K LM

MVI.5723.1 6 7 20W 4000K 1800

MVI.5723.1 6 8 20W 3000K 1700

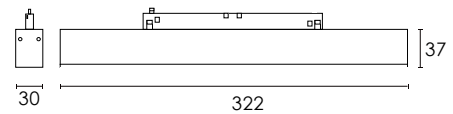

DONNA INFINITY

Donna Linear 48V profilo per il sistema MULTI TRACK 48V. Corpo in alluminio verniciato nero raggrinzato. Disponibile nella versione on-off o dimmerabile.

Donna Linear 48V LED for the MULTI TRACK 48V system. Aluminium body. Rough black colour. On/off or dimming versions available.

4000K/3000K

CODICE/CODE L. W LM

MVI.6703.D 6 Y L.286mm 6W 810/740

MVI.6704.D 6 Y L.567mm 12W 1600/1480

MVI.6705.D 6 Y L.1128mm 24W 3200/2970

DIMMERABILE DALI 4000K/3000K

CODICE/CODE L. W LM

MVI.6723.D 6 Y L.286mm 6W 810/740

MVI.6724.D 6 Y L.567mm 12W 1600/1480

MVI.6725.D 6 Y L.1128mm 24W 3200/2970

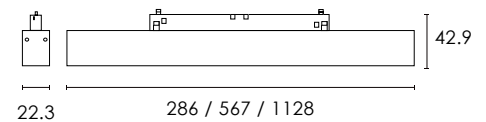
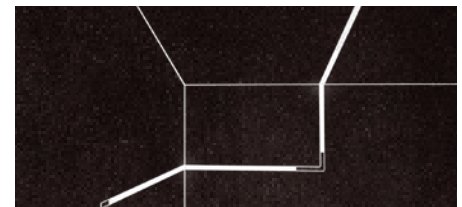

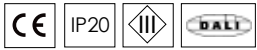

Binario standard 48V.
Standard track 48V.



CODICE/CODE DESCRIZIONE/DESCRIPTION

- MBL.4102.011** L.1m
- MBL.4102.012** L.2m
- MBL.4102.013** L.3m

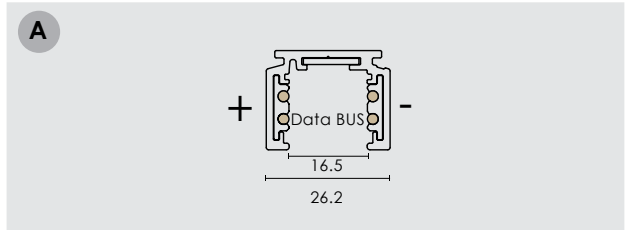

Binario basic 48V.
Basic track 48V.



CODICE/CODE DESCRIZIONE/DESCRIPTION

- MBL.4102.061** L.1m
- MBL.4102.062** L.2m
- MBL.4102.063** L.3m

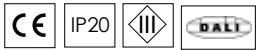
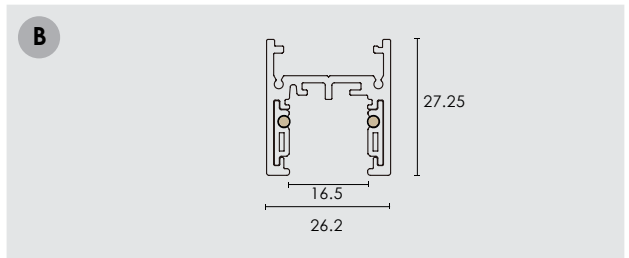

Binario H 48V.
Basic H 48V.



CODICE/CODE DESCRIZIONE/DESCRIPTION

- MBL.4102.021** L.1m
- MBL.4102.022** L.2m
- MBL.4102.023** L.3m

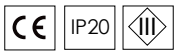
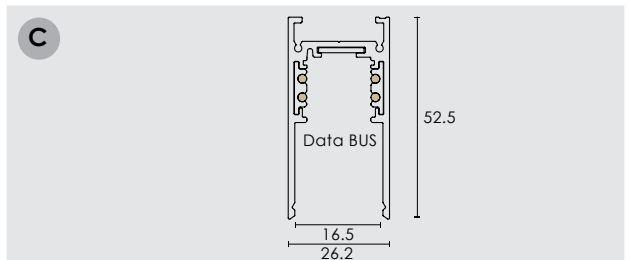

Binario da incasso trimless 48V.
Trimless recessed track 48V.



CODICE/CODE DESCRIZIONE/DESCRIPTION

- MBL.4102.131** L.1m
- MBL.4102.132** L.2m
- MBL.4102.133** L.3m

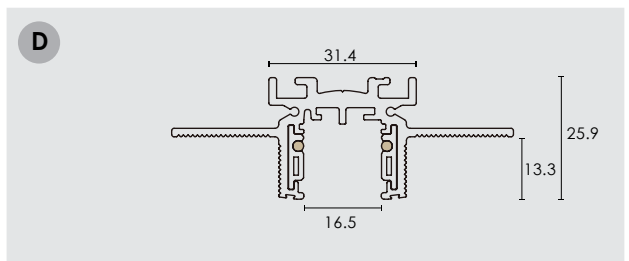

Binario da incasso trimless 48V.
Trimless recessed track 48V.



CODICE/CODE DESCRIZIONE/DESCRIPTION

- MBL.4102.101** L.1m
- MBL.4102.102** L.2m
- MBL.4102.103** L.3m

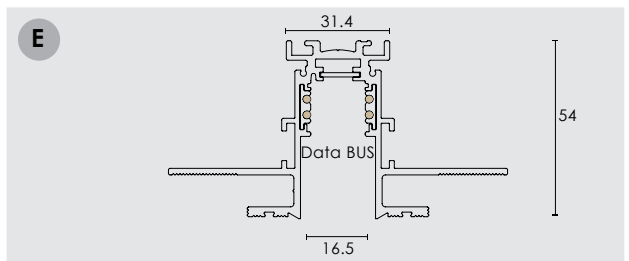

Diffusore opale/ microprismato.
Opal / microprismatic diffuser

CODICE/CODE DESCRIZIONE/DESCRIPTION

- MBL.4102.D 01** L.1m
- MBL.4102.D 02** L.2m
- MBL.4102.D 03** L.3m

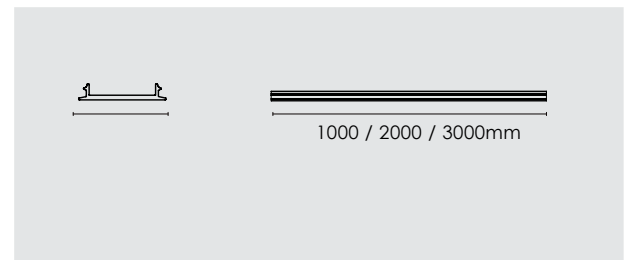
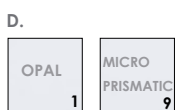



Alimentazione 48V.
Live end 48V.

CODICE/CODE DESCRIZIONE/DESCRIPTION

MBL.4102.ALD destra / right

MBL.4102.ALS sinistra / left

MBL.4102.ALN non polarizzata

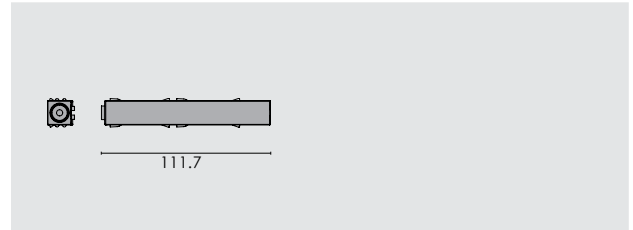

Giunto passante 48V.
Linear joint 48V.

CODICE/CODE DESCRIZIONE/DESCRIPTION

MBL.4102.CD

MBL.4102.CDN non polarizzato

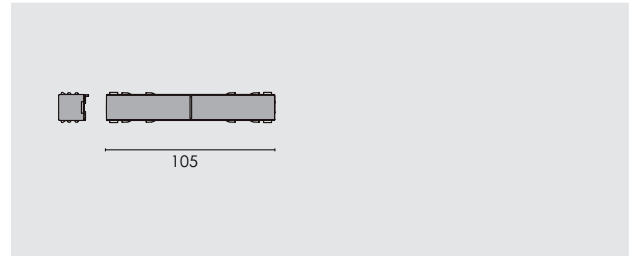

Giunto a L 48V.
L feed 48V.

CODICE/CODE DESCRIZIONE/DESCRIPTION

MBL.4102.CLD destra / right

MBL.4102.CLS sinistra / left

MBL.4102.CLN non polarizzata

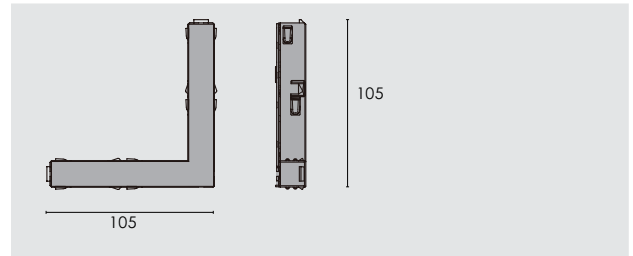

Tappo di chiusura per binari 48V.
End cap for 48V tracks.

CODICE/CODE DESCRIZIONE/DESCRIPTION

MBL.4102.TEA binario A, E

MBL.4102.TEB binario B

MBL.4102.TEC binario C, D

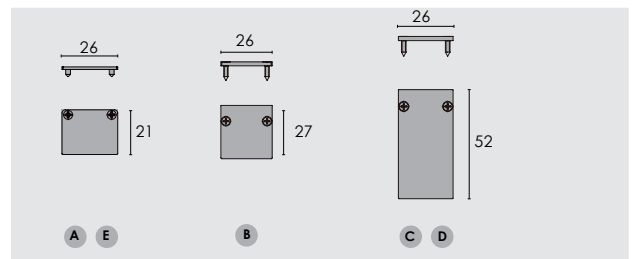

Kit sospensione per binari 48V.
Suspension kit for 48V tracks.

CODICE/CODE DESCRIZIONE/DESCRIPTION

MBL.4102.SOA binario A

MBL.4102.SOB binario B, C

MBL.4102.SOC binario D, E

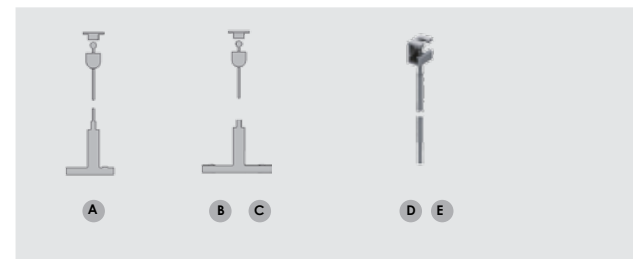

Kit d'alimentazione per binario 48V.
Power supply kit for 48V tracks.

CODICE/CODE DESCRIZIONE/DESCRIPTION

MBL.RA-1 ON/OFF

MBL.RA-A1 1-10V

MBL.RA-A1 DALI

